

UCHWYTY DO NACIĄGÓW UCHWYTY NACIĄGOWE wbijane pojedyncze

C192240



WERSJA MATERIAŁOWA:

stal ocynkowana ogniowo

OPIS:

Uchwyty do naciągów wbijane pojedyncze.

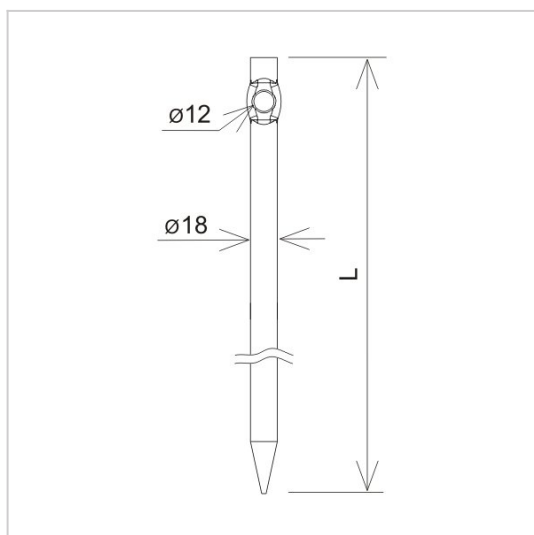

symbol	C192240
typ	AN-31E/OG/
L (mm)	400
wersja materiałowa	stal ocynkowana ogniowo



AN-KOM 2 Sp. z o.o.
Inwałd, ul. ks. Władysława
Bukowińskiego 15
34-120 Andrychów



an-kom.pl
biuro@an-kom.pl



tel./fax
+48 33 875 18 11
+48 33 870 60 88