

HOLDERS ROOF TILE universal holder

E464744

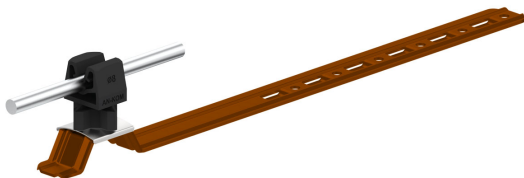

DOSTĘPNE W KOLORACH



MATERIAL:

painted

DESCRIPTION:

Tile holder - adjustable is used to build air terminals and lightning conductors on the roof across or along the tile. The holder is installed by bending the notch and inserting the holder between the tiles or screwing it to the batten with screws through the mounting holes.

AVAILABLE COLOURS:

RAL 3011 - **red**, RAL 8017 - **dark brown**, RAL 7016 - **anthracite grey**, RAL 7026 - **granite grey**, RAL 8004 - **brown (brick colour)**, RAL 9005 - **black**

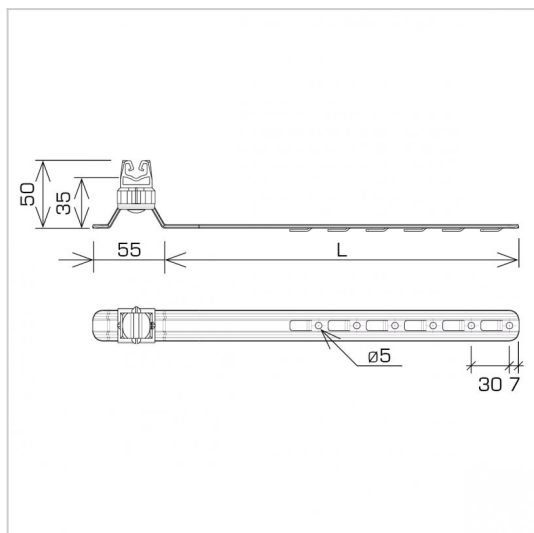

symbol	E464744
type	AN-19KPN/LA/C-N
pole colour	RAL 9005
L(mm)	280
cabl(e)mm	Ø8
material	painte



AN-KOM 2 Sp. z o.o.
Inwałd, ul. ks. Władysława
Bukowińskiego 15
34-120 Andrychów



an-kom.pl
sales@an-kom.pl



tel./fax
+48 605 527 132