

HOLDERS ROOF TILE universal twisted holder

E374604

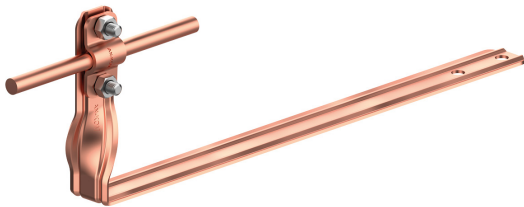

WERSJA MATERIAŁOWA:

copper

OPIS:

Tile holder - universal, twisted, used to build air terminals and lightning conductors on the roof along the tiles. The holder is mounted by screwing it to the batten through the mounting holes.

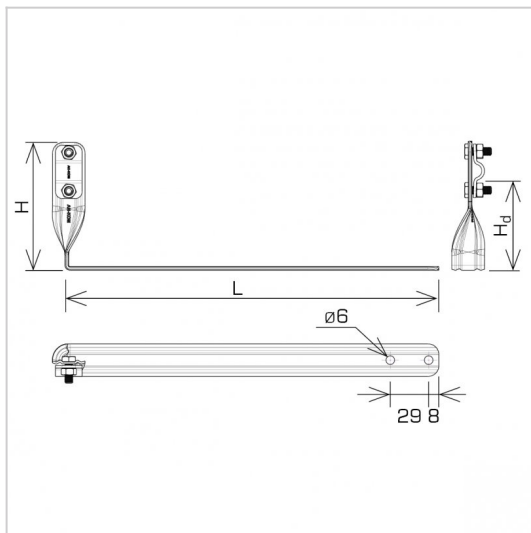

symbol	E374604
typ	AN-29A/CU/-N
L(mm)	420
H(mm)	96
Hd(mm)	70
cable(mm)	Ø8
wersja materiałowa	copper



AN-KOM 2 Sp. z o.o.
Inwałd, ul. ks. Władysława
Bukowińskiego 15
34-120 Andrychów



an-kom.pl
sales@an-kom.pl



tel./fax
+48 605 527 132