

HOLDERS ROOF TILE adjustable twisted holder

E374580

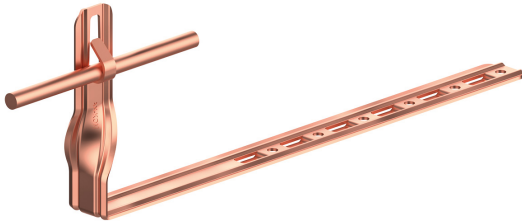

MATERIAL:

copper

DESCRIPTION:

Tile holder - adjustable, twisted, used to build air terminals and lightning conductors on the roof across the tile. The holder is installed by bending the notch and inserting the holder between the tiles or screwing it to the batten with screws through the mounting holes.

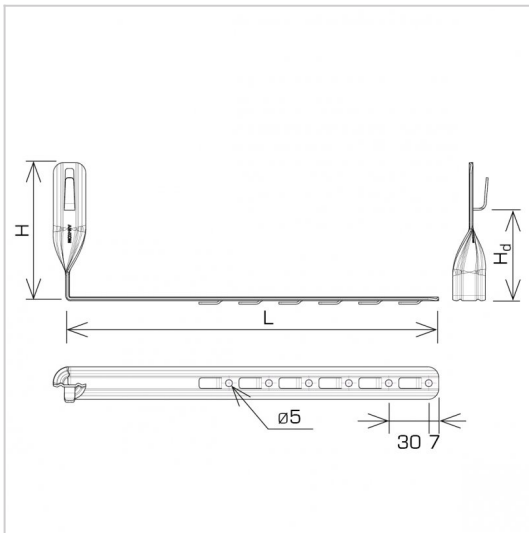

symbol type	E374580 AN-23KL/CU/-N
L(mm)	420
H(mm)	104
Hd(mm)	70
cable(mm)	Ø8
material	copper



AN-KOM 2 Sp. z o.o.
Inwałd, ul. ks. Władysława
Bukowińskiego 15
34-120 Andrychów



an-kom.pl
sales@an-kom.pl



tel./fax
+48 605 527 132