

HOLDERS ROOF TILE universal straight holder

E284600

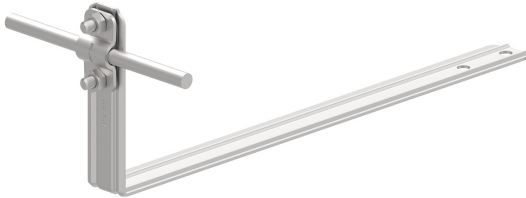

WERSJA MATERIAŁOWA:

stainless acid-resistant V4A steel

OPIS:

Tile holder - universal, straight, used to build air terminals and lightning conductors on the roof across the tile. The holder is mounted by screwing it to the batten through the mounting holes.

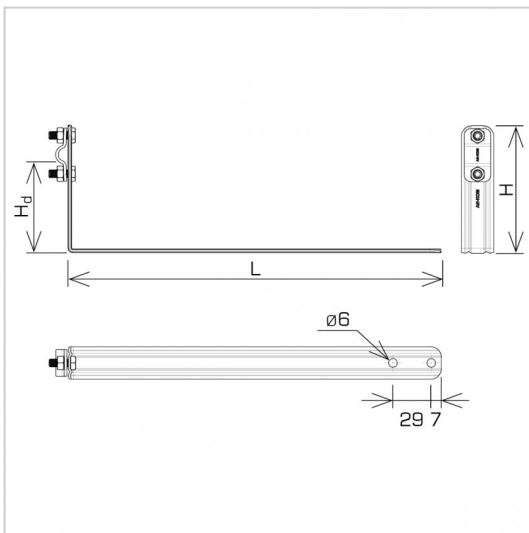

symbol typ	E284600 AN-26A/OH/-N
L(mm)	420
H(mm)	96
Hd(mm)	70
cablę(mm)	Ø8
wersja materiałowa	stainless acid-resistant V4A steel



AN-KOM 2 Sp. z o.o.
Inwałd, ul. ks. Władysława
Bukowińskiego 15
34-120 Andrychów



an-kom.pl
sales@an-kom.pl



tel./fax
+48 605 527 132