

HOLDERS ROOF TILE universal holder

E194744



WERSJA MATERIAŁOWA:

hot galvanised steel

OPIS:

Tile holder - adjustable is used to build air terminals and lightning conductors on the roof across or along the tile. The holder is installed by bending the notch and inserting the holder between the tiles or screwing it to the batten with screws through the mounting holes.

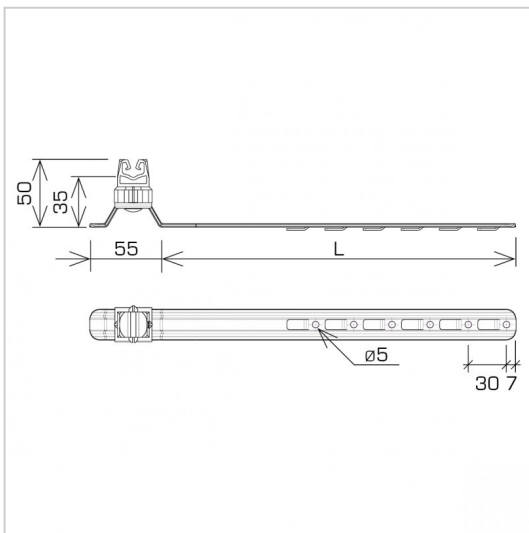

symbol typ	E194744 AN-19KPN/OG/C-N
pole colour	RAL 9005
L(mm)	280
cablę(mm)	Ø8
wersja materiałowa	hot galvanised steel



AN-KOM 2 Sp. z o.o.
Inwałd, ul. ks. Władysława
Bukowińskiego 15
34-120 Andrychów



an-kom.pl
sales@an-kom.pl



tel./fax
+48 605 527 132