

HOLDERS ROOF TILE adjustable straight holder

E194576



WERSJA MATERIAŁOWA:

hot galvanised steel

OPIS:

Tile holder - adjustable, straight, used to build air terminals and lightning conductors on the roof across the tile. The holder is installed by bending the notch and inserting the holder between the tiles or screwing it to the batten with screws through the mounting holes.

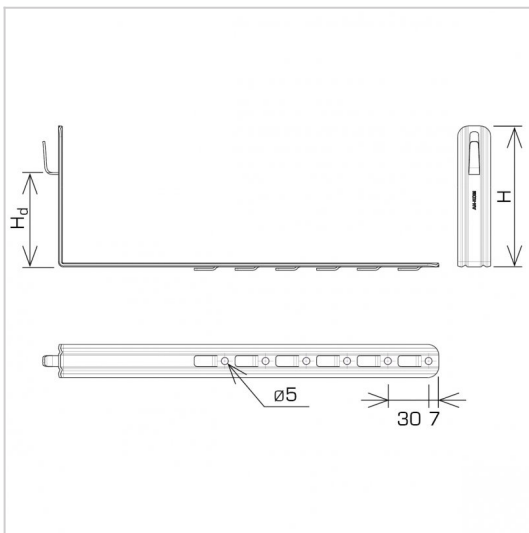

symbol typ	E194576 AN-20KL/OG/-N
L(mm)	420
H(mm)	104
Hd(mm)	70
cabale(mm)	Ø8
wersja materiałowa	hot galvanised steel



AN-KOM 2 Sp. z o.o.
Inwałd, ul. ks. Władysława
Bukowińskiego 15
34-120 Andrychów



an-kom.pl
sales@an-kom.pl



tel./fax
+48 605 527 132