

HOLDERS TAPE CONDUCTOR screw-in

C462352

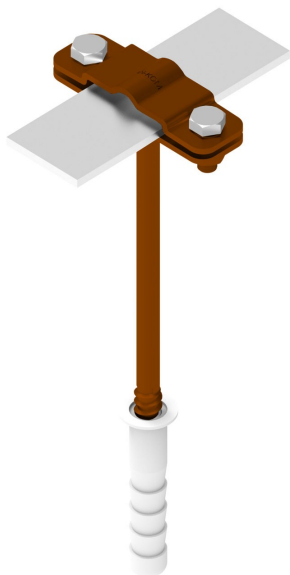

WERSJA MATERIAŁOWA:

painted

OPIS:

Flat conductor (tape conductor holder) mounting holder with expansion bolt included. Wall or foundation mounting.

*B - maximum tape conductor holder width

AVAILABLE COLOURS:

RAL 3011 - **red**, RAL 8017 - **dark brown**, RAL 7016 - **anthracite grey**, RAL 7026 - **granite grey**, RAL 8004 - **brown (brick colour)**, RAL 9005 - **black**

DOSTĘPNE W KOLORACH

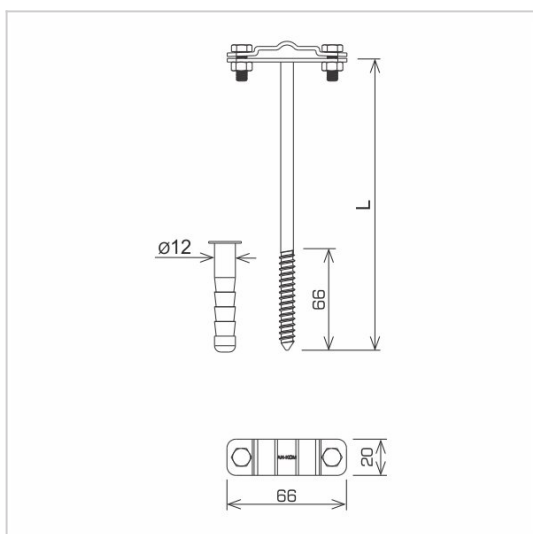

symbol typ	C462352 AN-43A/LA/
L(mm)	210
conductor(mm)	B* to 30 or Ø8
wersja materiałowa	painted



AN-KOM 2 Sp. z o.o.
Inwałd, ul. ks. Władysława
Bukowińskiego 15
34-120 Andrychów



an-kom.pl
sales@an-kom.pl



tel./fax
+48 605 527 132