

HOLDERS WIRE screw-in

C462348



WERSJA MATERIAŁOWA:

painted

OPIS:

Screw-in holder for routing the ground wire on the facade, wooden structures.

AVAILABLE COLOURS:

RAL 3011 - **red**, RAL 8017 - **dark brown**, RAL 7016 - **anthracite grey**,
RAL 7026 - **granite grey**, RAL 8004 - **brown (brick colour)**, RAL 9005 -
black

DOSTĘPNE W KOLORACH

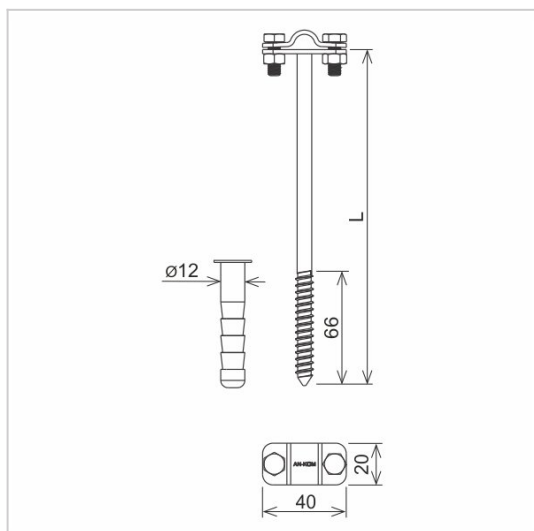

symbol	C462348
typ	AN-43/LA/
L(mm)	210
conductor(mm)	Ø8
wersja materiałowa	painted



AN-KOM 2 Sp. z o.o.
Inwałd, ul. ks. Władysława
Bukowińskiego 15
34-120 Andrychów



an-kom.pl
sales@an-kom.pl



tel./fax
+48 605 527 132