

HOLDERS UNIVERSAL pipes and wires universal holders

C192720



**WERSJA MATERIAŁOWA:**

hot galvanised steel

**OPIS:**

Designed for fixing pipes / wires, offered in a wide range of sizes.

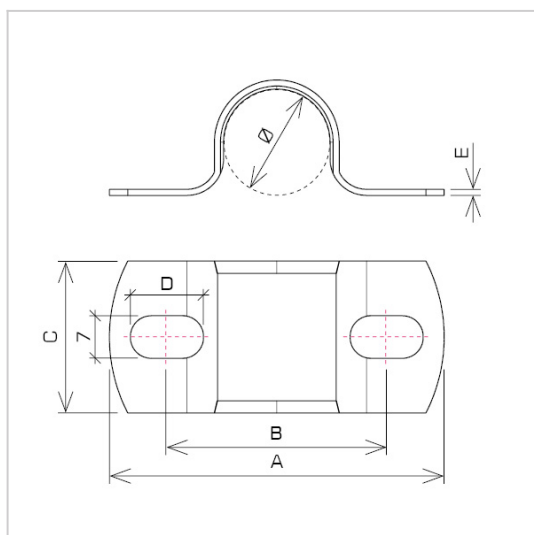

symbol typ	<b>C192720</b> AN-RU10/OG/
Ø(mm)	30
A(mm)	72
B(mm)	53
C(mm)	30
D(mm)	12
E(mm)	1,5
wersja materiałowa	hot galvanised steel



AN-KOM 2 Sp. z o.o.  
Inwałd, ul. ks. Władysława  
Bukowińskiego 15  
34-120 Andrychów



an-kom.pl  
sales@an-kom.pl



tel./fax  
+48 605 527 132