

HOLDERS TAPE CONDUCTOR screw-in

C192344



WERSJA MATERIAŁOWA:

hot galvanised steel

OPIS:

Flat conductor (tape conductor holder) mounting holder with expansion bolt included. Wall or foundation mounting.

*B - maximum tape conductor holder width

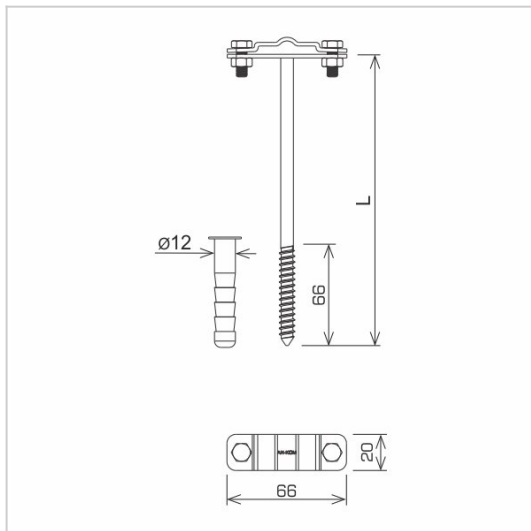

symbol typ	C192344 AN-42A/OG/
L(mm)	180
conductor(mm)	B* to 30 or Ø8
wersja materiałowa	hot galvanised steel



AN-KOM 2 Sp. z o.o.
Inwałd, ul. ks. Władysława
Bukowińskiego 15
34-120 Andrychów



an-kom.pl
sales@an-kom.pl



tel./fax
+48 605 527 132