

HOLDERS TAPE CONDUCTOR hammered

C192288

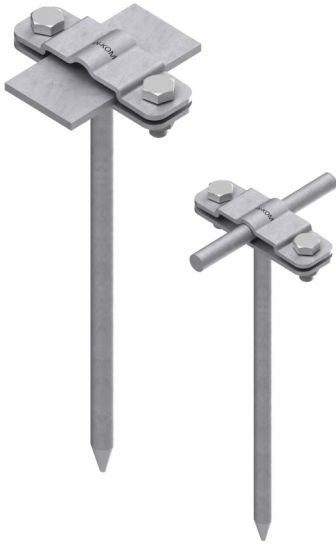

WERSJA MATERIAŁOWA:

hot galvanised steel

OPIS:

For routing flat conductors (tape conductor holder) along the wall or foundation. The holder designed for wooden constructions. Installation is done by hammering the handle into the ground.

*B - maximum tape conductor holder width
The holder is also used to mount the round conductor.

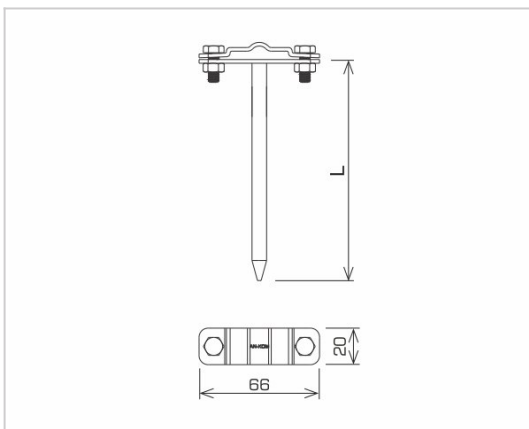

| | |
|---------------------------|------------------------------|
| symbol typ | C192288 AN-33A/OG/ |
| L(mm) | 160 |
| conductor(mm) | B* to 30 or Ø8 |
| wersja materiałowa | hot galvanised steel |



AN-KOM 2 Sp. z o.o.
Inwałd, ul. ks. Władysława
Bukowińskiego 15
34-120 Andrychów



an-kom.pl
sales@an-kom.pl



tel./fax
+48 605 527 132