

HOLDERS TAPE CONDUCTOR screw-down

C192140

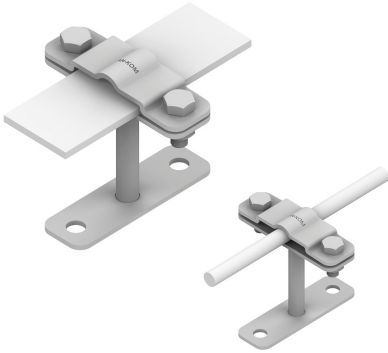

MATERIAL:

hot galvanised steel

DESCRIPTION:

For routing flat conductors (tape conductor holder) without spacers on the wall or foundation. Mounting the holder to the ground with an expansion bolt.

*B - maximum width of the tape conductor holder

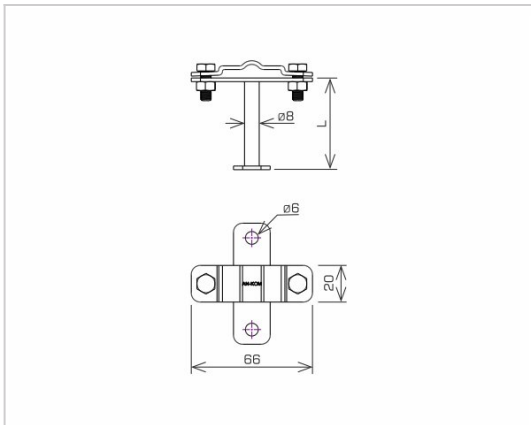

symbol type	C192140 AN-11T-50/OG/
L(mm)	50
conductor(mm)	B* to 30 or Ø8
material	hot galvanised steel



AN-KOM 2 Sp. z o.o.
Inwałd, ul. ks. Władysława
Bukowińskiego 15
34-120 Andrychów



an-kom.pl
sales@an-kom.pl



tel./fax
+48 605 527 132